



R3-R8D Smart Deadbolt  
**Installation**  
**Programming**  
**Bluetooth Pairing**



## Parts in the box



Deadbolt



Strike Box



Strike

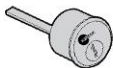

Cylinder



Touch Screen



Keys



Interior  
Assembly



Mounting  
Plate



Fixture  
Plate



Alkaline  
Batteries

## Screws in the box

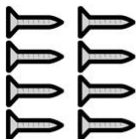

### Screw A

Deadbolt x 2  
Strike Box x 2  
Mounting Plate x 4



B1



B2

### Screw B Touchscreen

Door thickness  
35-46 mm (B1)  
47-55 mm (B2)



### Pin Cylinder

C1

C2



### Screw C Cylinder

Door thickness  
35-46 mm (C1)  
47-55 mm (C2)



### Screw D

Interior Assembly  
(top)



### Hex Screw E

Interior Assembly  
(bottom)

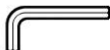

### Hex Key Wrench

## Check the door dimensions

- A Measure to confirm that the hole in the door is 2-1/8" (54 mm)

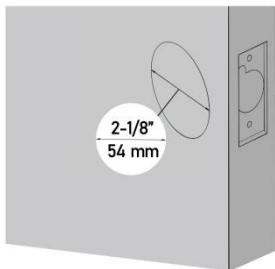

- B Measure to confirm that backset is either 2-3/8 or 2-3/4" (60 or 70 mm)

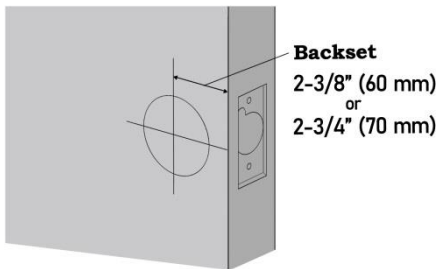

- C Measure to confirm that the hole in the door edge is 1" (25 mm).

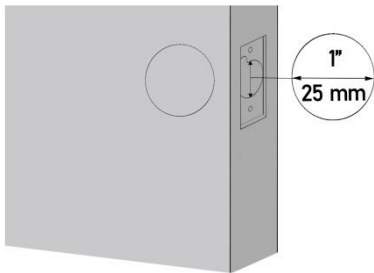

- D Measure to confirm that the door is from 1-3/8" (35 mm) to 2-1/8" (55 mm) thick.

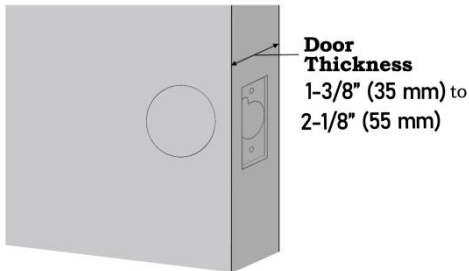

## Prepare Tools

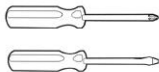

Phillips & Slotted  
Screwdriver



Drill Bit  
13/32"  
10 mm



Power Drill

## Additional Tools



Diagonal Cutter x 2pcs

Only for door thickness  $\leq 1\text{-}3/4"$  (45 mm), not needed for door thickness  $> 1\text{-}3/4"$  (45 mm)

- △ Use a screwdriver to install the lock.
- △ Don't use power tools to install the lock, only use power tools to drill the necessary holes.

## Remove Existing Lock

Remove the entire deadbolt, including the bolt. Also, remove the strike box from the door frame.

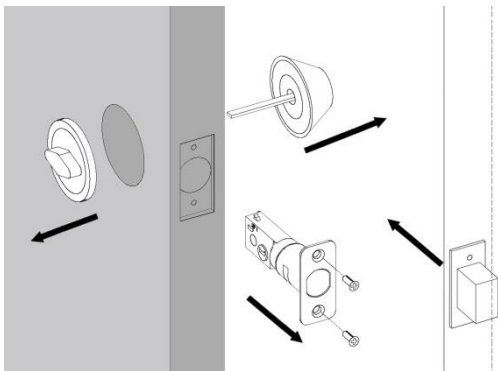

# Installation View

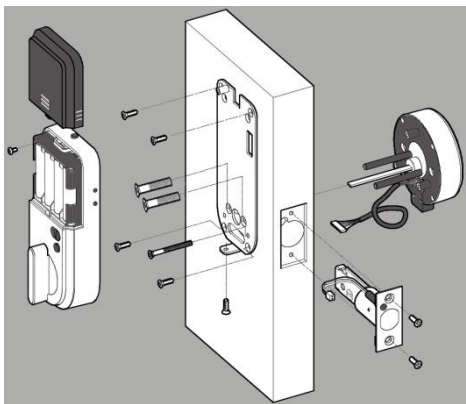



# **1** Check the Door Backset

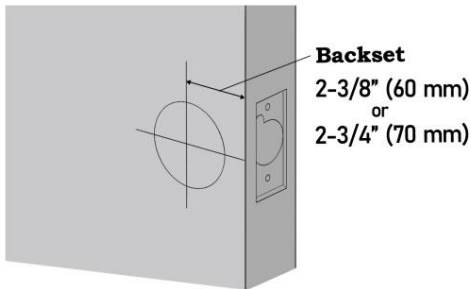

## 2 Drill a Hole for the Door

### Sensor

- A Place the fixture plate on the original latch screw holes of the door. As for different door's backset  $2\text{-}3/8"$ , or  $2\text{-}3/4"$ , place the fixture plate in different placement according to the diagram below.

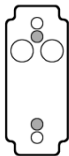
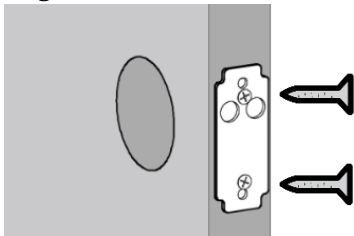

$2\text{-}3/8"$  (60 mm)

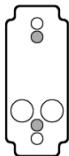

$2\text{-}3/4"$  (70 mm)

- B** Drill a hole for the latch sensor.  
Follow the diagram below for drilling hole's direction according to different door's backset.

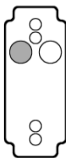
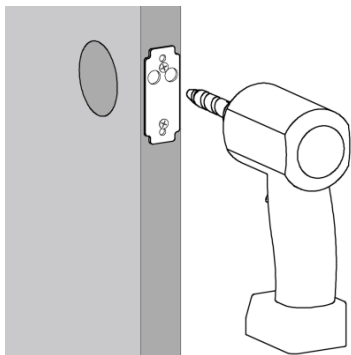

2-3/8" (60 mm)

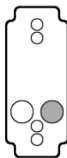

2-3/4" (70 mm)

- Remove the fixture plate after the hole is drilled.

### 3 Install the Deadbolt

#### A Door's backset 2-3/8" (60 mm)

Make sure the slot in the bolt is centered in the hole, "UP" is facing upward, sensor on the top side.

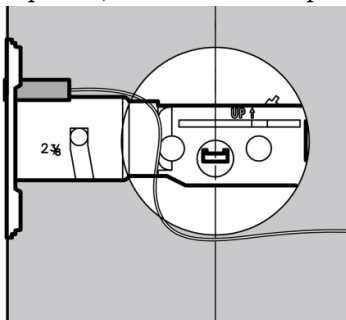

Backset 2-3/8 (60 mm)

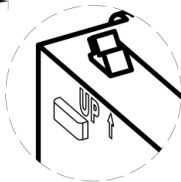
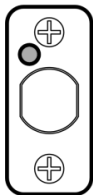

**B Door's backset 2-3/4" (70 mm)**

Hold the faceplate and twist the body to extend the latch from 60 mm to fit the door's backset 70 mm.

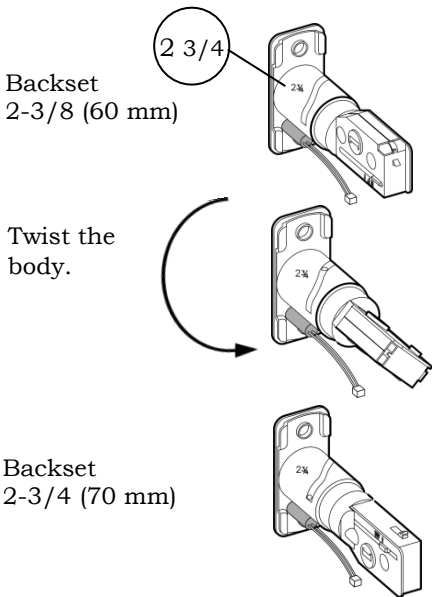

- Make sure the slot in the bolt is centered in the hole, “UP” is facing upward, sensor on the bottom side.

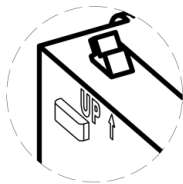
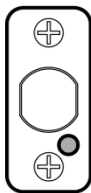
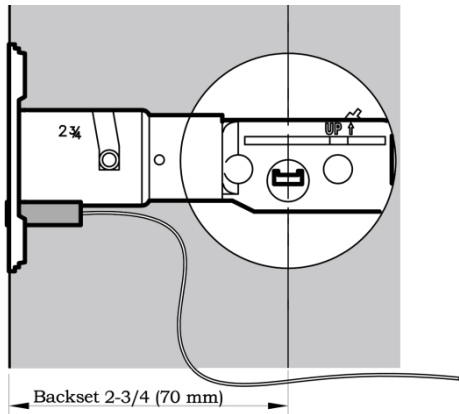

**D** Install the deadbolt with screw A.

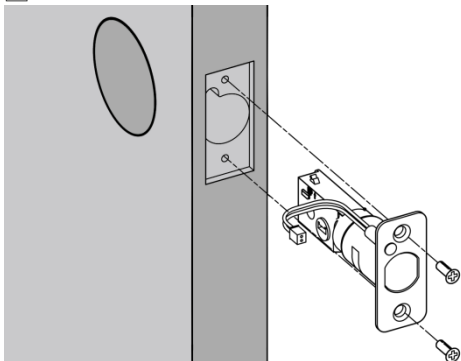



- E Use a screwdriver to test that the deadbolt extends and retracts smoothly in both directions.

Keep deadbolt retracted (unlocked) after testing.

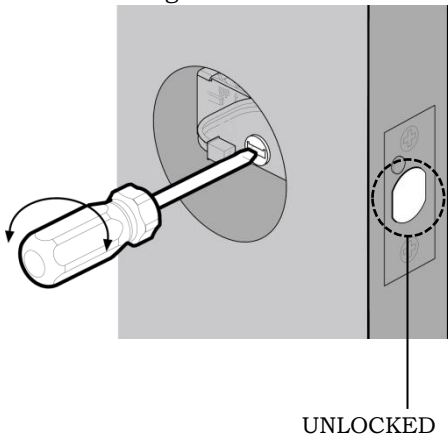

## **4** Install the Strike Box

- A** Place the fixture plate on original holes of the strike box of the door frame.

As for different door's backset 2-3/8", or 2-3/4", place the fixture plate in different placement according to the diagram below.

Use screw A to fix the plate.

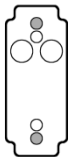
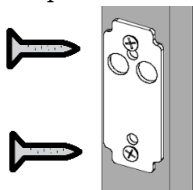

2-3/8" (60 mm)

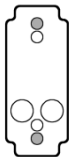

2-3/4" (70 mm)

- B** Drill a hole for the magnet of the strike box. Follow the diagram below for drilling hole's direction according to different door's backset

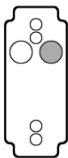
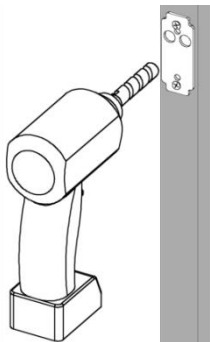

2-3/8" (60 mm)

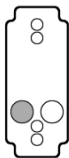

2-3/4" (70 mm)

- Remove the fixture plate after the hole is drilled.

D Install the strike and strike box.

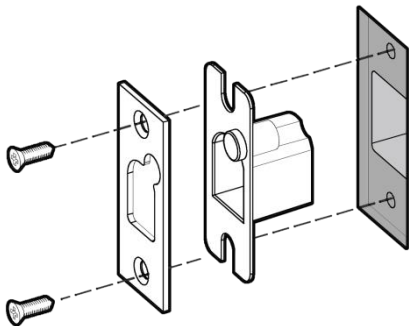

Strike & Strike Box direction

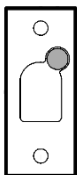

2-3/8" (60 mm)

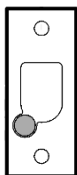

2-3/4" (70 mm)

**E** Use screw A for installation.

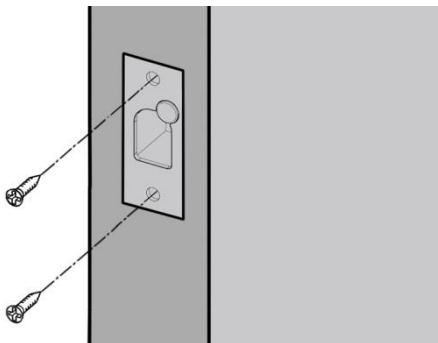

## 5 Assemble the Exterior

### Assembly and Cylinder

Before installation, compare the tailpiece length to the door thickness. Trim the tailpiece length according to the picture below if the door thickness less than 1-3/4" (45 mm).

If the door thickness is more than 1-3/4" (45 mm), skip this step.

Door  
Thickness  $\leq$  1-3/4" (45 mm)

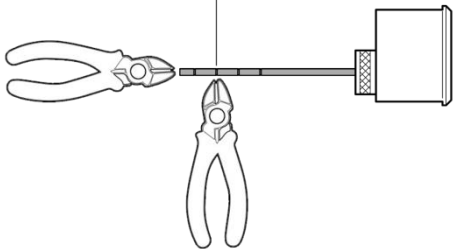

- A** Insert cylinder into touch screen.  
“KevLok” on the cylinder is on top.

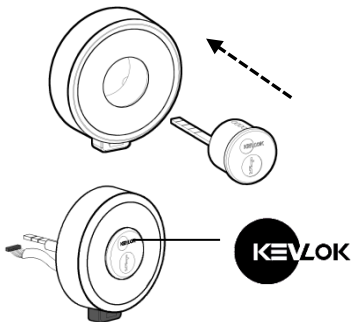

- B** Screw cylinder pins into cylinder.

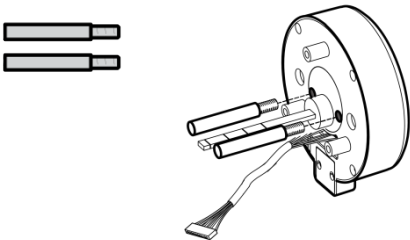



**C** Adjust the tailpiece direction.

Make sure the painted edge of tailpiece facing in the same direction as the latch bolt.

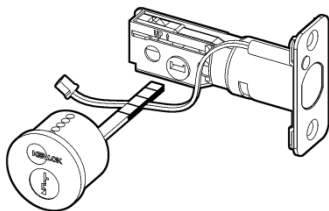
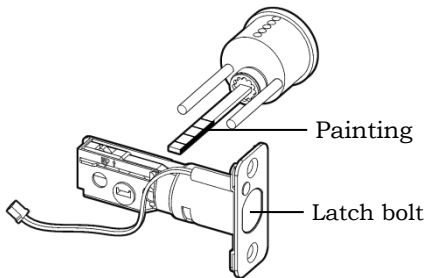

- D Make sure the latch is fully retracted

Both cables go underneath the latch.  
Align the tailpiece through the slot  
in the latch, painted edge face to the  
latch bolt direction.

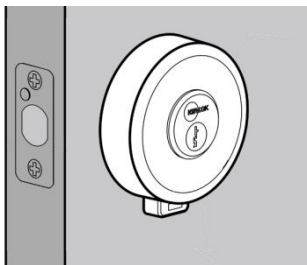
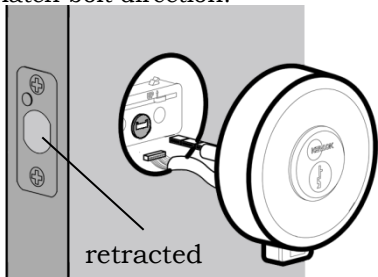

## 6 Install the Mounting Plate

- A Tailpiece and cables go through the mounting plate.

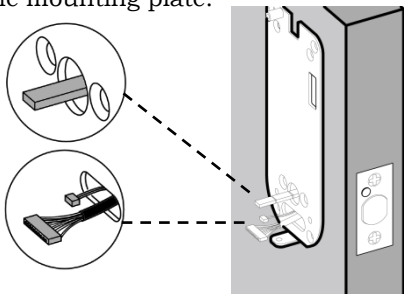

- B Tighten screws B & C. Screw B is to be placed one of holes close to the latch bolt side.

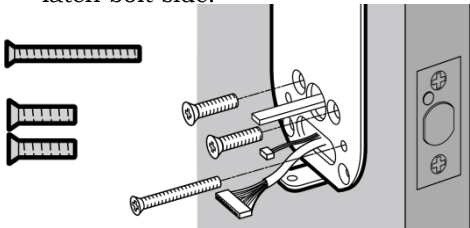

- C Use a key to test locking and unlocking works smoothly.

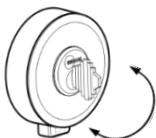

- D Secure the mounting plate with screw A. Make sure the outside touchscreen is straight before tightening screws.

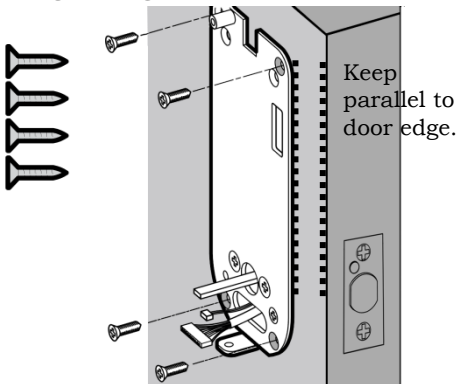

## **7** Install the Interior

### **Assembly**

- A** Remove battery cover. Do not load batteries until the lock is completely installed.

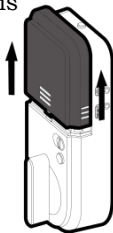

- B** Connect cables to the interior assembly. Make sure cables "click" into place. Tuck cables inside the space of the door.

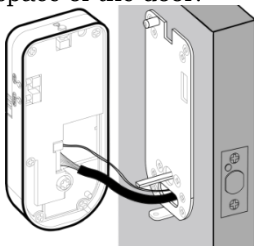

- Ⓒ Adjust the thumb turn position either vertically or horizontally depending on deadbolt orientation. Tailpiece must be horizontal.

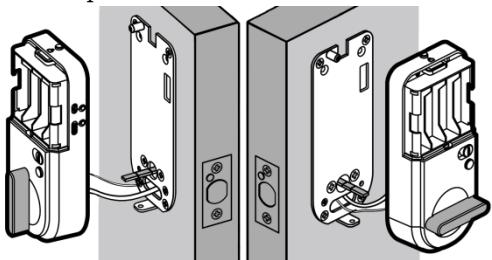

- Ⓓ Align the tailpiece with the spindle of interior assembly.

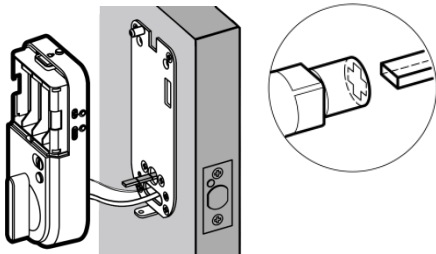

- E** Make sure the tailpiece in horizontal position, thumb turn position as step C likewise, and deadbolt is retracted. Test operation using a key and thumb turn for rotation.

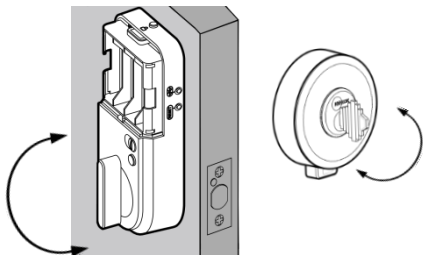

- F** Secure with screws D, use hex key wrench to fix hex screw E.

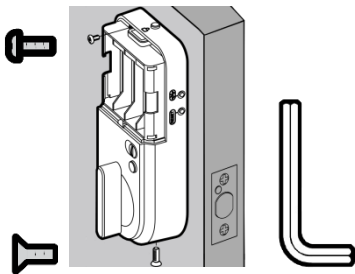

## **8 Perform the Door Handing Process**

△ This step will teach the lock which side of the door it is on, crucial for the lock to operate properly according to the door orientation.

A Leave latch bolt UNLOCKED and slide the switch to the RIGHT side.

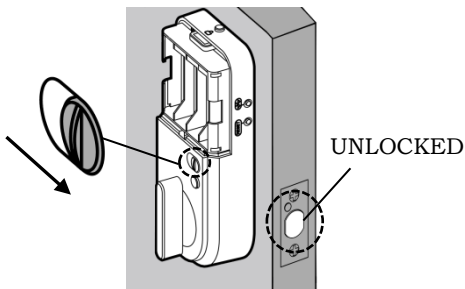



Make sure only use non-rechargeable AA Alkaline batteries.

- B** Load 3 pcs AA batteries, press and hold vacation-mode button.

Vacation-mode  
button

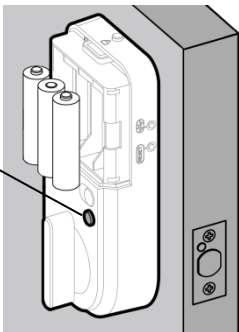

- C** Continue pressing vacation-mode button. Load the last battery and release vacation-mode button when You hear the melody.
- D** The bolt will extend and retract. The door handing process is now completed.

- E** Turn the thumb turn to extend the bolt, and then press quick-unlock button to retract the bolt.

If it works in order, the lock is functioning properly.

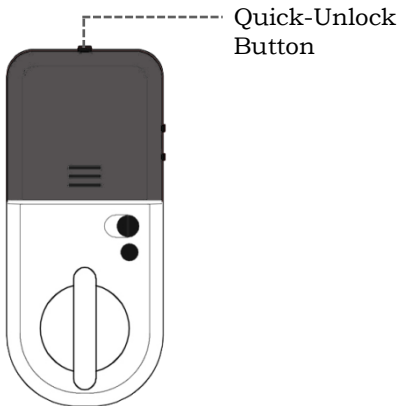

## **Two Administration Modes**

### **EZ mode**

1. ONE user code is available.
2. One-time user code is not available.
3. Keypad sound cannot be turned off.

### **Normal mode**

1. Maximum 200 user codes.
2. One one-time code is available.
3. Keypad sound can be turned off.

△ KevLok App can assign another 10 user codes, and 10 one-time user codes.

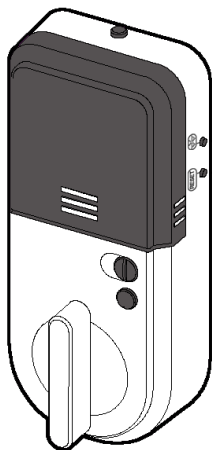

Bluetooth paired  
button

Reset button

## Programming & Setting

### Master Code (4 to 6 digits)

Make sure only use non-rechargeable AA Alkaline batteries.

- A Remove one of batteries, press and hold the Reset button.
- B Load the last battery and keep holding the reset button, do not release it until you hear a melody.
- C Slide the touch screen around the panel, touch screen light up, enter the default code **\*3#8**
- D Enter **3#** for **EZ** mode, or **8#** for **Normal** mode.
- E Enter **Master Code** + **#**
- F Enter **Master Code** again + **#**
- G **\*** will be on, and off.

- △ When you perform the above steps programming and setting the master code, please do it before backlit goes off, if you enter numbers or symbols after backlit goes off, please restart the programming process.

## **Unlock the door**

- A Extend the bolt using the inside thumbturn. Leave door open, or close the door with the key in hand
- B Slide the touch screen around the panel, enter the **Master Code** and **#**
- C The bolt will retract to unlock the lock. The programming process is completed.

## Set up your smartphone with KevLok APP

- [A] Download KevLok app from the App Store, or Google Play.



Make sure only use non-rechargeable AA Alkaline batteries.

- [B] Remove one of batteries, press and hold the Bluetooth button.
- [C] Load the last battery and release Bluetooth button when melody sounds.
- [D] Turn on **Bluetooth** and **GPS** on your smart phone. Bring your phone within an arm-reached distance from the touch screen.
- [E] Open the KevLok app. The lock icon will show up in green if Bluetooth is connected to the lock device.

- F Tap the green lock icon.
  - G Press Bluetooth button on lock device for 3-5 seconds.
  - H Release Bluetooth button, go to KevLok app, it will show “Paired”, then press “OK”.
  - I Tap the green lock icon.
  - J Tap the lock icon to unlock the lock.
- △ Make sure Master Code is set up before proceeding above KevLok pairing steps.



## **KevLok Function**

For a demonstration video of Bluetooth pairing, and each function of the KevLok, please scan the QR code, the videos are under the “Manual” tab.

There is an index underneath the video for each of the KevLok functions, you can connect the timeline link to find the specific functions you need.



The QR code label is on the battery cover inside.

## **System Reset**

Resetting your lock will restore your lock to factory settings, and delete all user codes, including the master code.

If you wish to perform a system reset, follow the same steps as Programming & Setting Master Code.

## **KevLok App Reset**

Resetting the KevLok App will erase pairing settings, and other distributed smart keys. However, assigned one-time user code, and permanent user codes still remain.

We suggest deleting all user codes before proceeding to the reset process, or System Reset can also delete these codes.

If you wish to reset your KevLok App, follow the same steps as Set up your smartphone with KevLok app.

## **FCC Statement**

This device complies with part 15 of the FCC Rules. Operation is subject to the following two conditions: (1) This device may not cause harmful interference, and (2) this device must accept any interference received, including interference that may cause undesired operation.

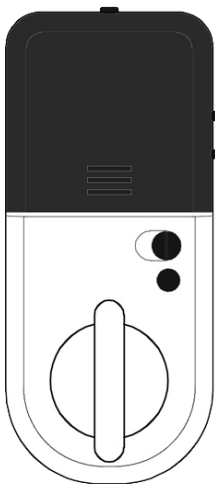

R3-R8D Smart Deadbolt  
**Installation**  
**Programming**  
**Bluetooth Pairing**

